



NIKKEN eu

SHRINK-FIT TOOLHOLDERS

NIKKEN EU Tool Holding Solutions

NIKKEN TOOLHOLDERS

NIKKEN are proud to launch and bring to market the latest range of cost-effective tool holding solutions.

This new range is part of our brand new sub-brand, 'NIKKEN EU', which sees the tool holding range sourced from our own NIKKEN certified European manufacturer.

These solutions have been globally available and proven over several years through existing NIKKEN networks. They provide the quality and performance guarantees expected from a NIKKEN solution, but with a unique twist. The combination of a more 'local' production and logistics costs make this tool holding range an affordable solution.

The new range of NIKKEN Shrink-Fit tool holders has been carefully considered and developed to meet the requirements and demands of a competitive market. NIKKEN EU solutions will maintain and deliver NIKKEN's renowned quality and support while providing a premium feel to the usual expectations of similar solutions at this price point.

Our new Shrink-Fit range has been manufactured and produced using carefully selected materials and processes to suit the majority of machine, tool shank and application requirements. (NIKKEN NBT, HSK, DIN69871/IT and Polygon tapers).

The range is 100% ground with options available to suit any length, diameter and clearance requirement. NIKKEN EU also supply, from stock, various options for coolant control to meet the specifics of the respective cutting tool (for example through or around the tool).

CONTENTS

POLYGONAL 4

C6-ISO26623 THERMO Shrink-Fit Chuck
C6-ISO26623 THERMO Shrink-Fit Chuck with Internal Coolant
C8-ISO26623 THERMO Shrink-Fit Chuck
C8-ISO26623 THERMO Shrink-Fit Chuck with Internal Coolant

NBT DUAL CONTACT 6

NBT30 THERMO Shrink-Fit Chuck
NBT30 THERMO Shrink-Fit Chuck with Internal Coolant
NBT40 THERMO Shrink-Fit Chuck
NBT40 THERMO Shrink-Fit Chuck with Internal Coolant
NBT40 THERMO Shrink-Fit Chuck Slim
NBT50 THERMO Shrink-Fit Chuck Slim
NBT50 THERMO Shrink-Fit Chuck with Internal Coolant

IT40 SK (DIN 69871) 10

IT40 THERMO Shrink-Fit Chuck
IT40 THERMO Shrink-Fit Chuck with Internal Coolant
IT40 THERMO Shrink-Fit Chuck Slim
IT50 THERMO Shrink-Fit Chuck Slim
IT50 THERMO Shrink-Fit Chuck with Internal Coolant

HSK63A 13

HSK63A THERMO Shrink-Fit Chuck
HSK63A THERMO Shrink-Fit Chuck Slim
HSK63A THERMO Shrink-Fit Chuck with Internal Coolant

HSK100A 15

HSK100A THERMO Shrink-Fit Chuck

C6-ISO26623

THERMO Shrink-Fit Chuck

Code	Type	x1	d1	d2	d3	x2
C6-SF3-80	STANDARD	80	3	9	16	-
C6-SF3-120	STANDARD	120	3	9	18	-
C6-SF4-80	STANDARD	80	4	10	17	-
C6-SF4-120	STANDARD	120	4	10	19	-

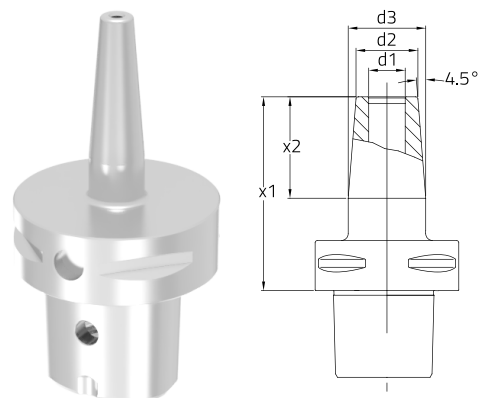

C6-ISO26623

THERMO Shrink-Fit Chuck with Internal Coolant

Code	Type	x1	d1	d2	d3	x2
C6-SF6-80CP	Internal coolant (IKZ)	80	6	21	27	37
C6-SF6-120CP	Internal coolant (IKZ)	120	6	21	27	37
C6-SF8-80CP	Internal coolant (IKZ)	80	8	21	27	37
C6-SF8-120CP	Internal coolant (IKZ)	120	8	21	27	37
C6-SF10-80CP	Internal coolant (IKZ)	80	10	24	32	41
C6-SF10-120CP	Internal coolant (IKZ)	120	10	24	32	41
C6-SF12-80CP	Internal coolant (IKZ)	80	12	24	32	47
C6-SF12-120CP	Internal coolant (IKZ)	120	12	24	32	47
C6-SF16-85CP	Internal coolant (IKZ)	85	16	27	34	50
C6-SF16-120CP	Internal coolant (IKZ)	120	16	27	34	50
C6-SF20-85CP	Internal coolant (IKZ)	85	20	33	42	52
C6-SF20-120CP	Internal coolant (IKZ)	120	20	33	42	52
C6-SF25-90CP	Internal coolant (IKZ)	90	25	44	53	58
C6-SF25-120CP	Internal coolant (IKZ)	120	25	44	53	58

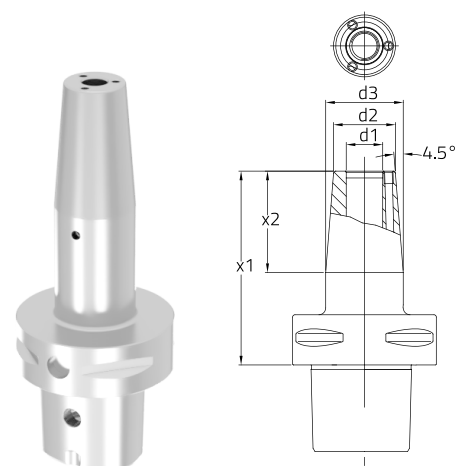

C8-ISO26623

THERMO Shrink-Fit Chuck

Code	Type	x1	d1	d2	d3	x2
C8-SF3-85	STANDARD	85	3	9	16	-
C8-SF3-130	STANDARD	130	3	9	18	-
C8-SF4-85	STANDARD	85	4	10	17	-
C8-SF4-130	STANDARD	130	4	10	19	-

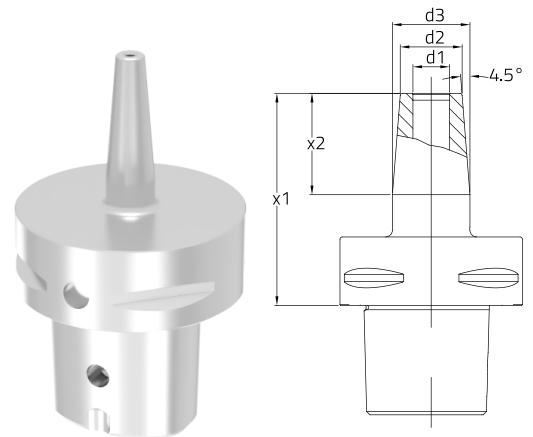

C8-ISO26623

THERMO Shrink-Fit Chuck with Internal Coolant

Code	Type	x1	d1	d2	d3	x2
C8-SF6-85CP	Internal coolant (IKZ)	85	6	21	27	37
C8-SF6-130CP	Internal coolant (IKZ)	130	6	21	27	37
C8-SF8-85CP	Internal coolant (IKZ)	85	8	21	27	37
C8-SF8-130CP	Internal coolant (IKZ)	130	8	21	27	37
C8-SF10-85CP	Internal coolant (IKZ)	85	10	24	32	41
C8-SF10-130CP	Internal coolant (IKZ)	130	10	24	32	41
C8-SF12-85CP	Internal coolant (IKZ)	85	12	24	32	47
C8-SF12-130CP	Internal coolant (IKZ)	130	12	24	32	47
C8-SF16-90CP	Internal coolant (IKZ)	90	16	27	34	50
C8-SF16-130CP	Internal coolant (IKZ)	130	16	27	34	50
C8-SF20-90CP	Internal coolant (IKZ)	90	20	33	42	52
C8-SF20-130CP	Internal coolant (IKZ)	130	20	33	42	52
C8-SF25-90CP	Internal coolant (IKZ)	90	25	44	53	58
C8-SF25-130CP	Internal coolant (IKZ)	130	25	44	53	58

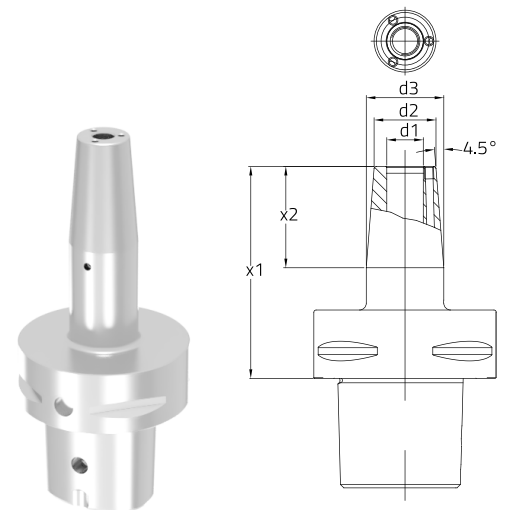

NBT DUAL CONTACT

Our Shrink Fit solutions feature an optional adaptable coolant system. Similar to NIKKEN's 'Jet Coolant' range the adaptable coolant consists of three 'Jet' holes which can very simply be plugged using grub screws (included). This provides the user with the choice of either cooling through the tool or cooling around the tool whichever is most appropriate for the required process.

NBT30

THERMO Shrink-Fit Chuck

Code	Type	x1	d1	d2	d3	d4	x2
NBT30-SF3-90	STANDARD	90	3	9	16	-	-
NBT30-SF3-120	STANDARD	120	3	9	16	-	-
NBT30-SF4-90	STANDARD	90	4	10	17	-	-
NBT30-SF4-120	STANDARD	120	4	10	17	-	-

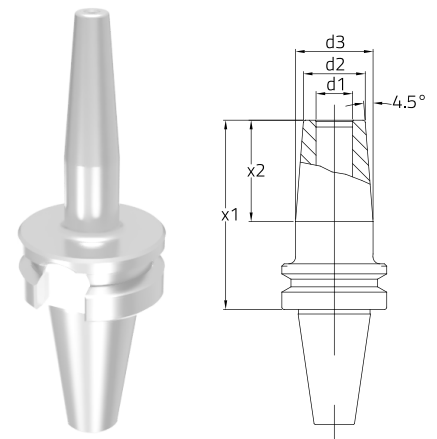

NBT30

THERMO Shrink-Fit Chuck with Internal Coolant

Code	Type	x1	d1	d2	d3	d4	x2
NBT30-SF6C-90	Internal coolant (IKZ)	90	6	21	27	-	37
NBT30-SF6C-120	Internal coolant (IKZ)	120	6	21	27	-	37
NBT30-SF8C-90	Internal coolant (IKZ)	90	8	21	27	-	37
NBT30-SF8C-120	Internal coolant (IKZ)	120	8	21	27	-	37
NBT30-SF10C-90	Internal coolant (IKZ)	90	10	24	32	-	41
NBT30-SF10C-120	Internal coolant (IKZ)	120	10	24	32	-	41
NBT30-SF12C-90	Internal coolant (IKZ)	90	12	24	32	-	47
NBT30-SF12C-120	Internal coolant (IKZ)	120	12	24	32	-	47
NBT30-SF16C-90	Internal coolant (IKZ)	90	16	27	34	-	50
NBT30-SF16C-120	Internal coolant (IKZ)	120	16	27	34	-	50

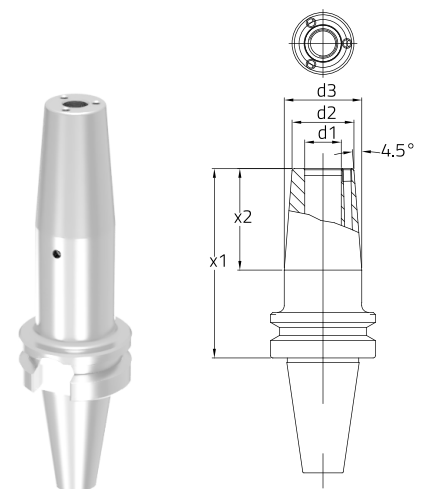

NBT40

THERMO Shrink-Fit Chuck

Code	Type	x1	d1	d2	d3	d4*	x2
NBT40-SF3-90	STANDARD	90	3	9	16	-	-
NBT40-SF3-120	STANDARD	120	3	9	16	-	-
NBT40-SF3-160	STANDARD	160	3	9	16	21.9	-
NBT40-SF4-90	STANDARD	90	4	10	17	-	-
NBT40-SF4-120	STANDARD	120	4	10	17	-	-
NBT40-SF4-160	STANDARD	160	4	10	17	22.9	-

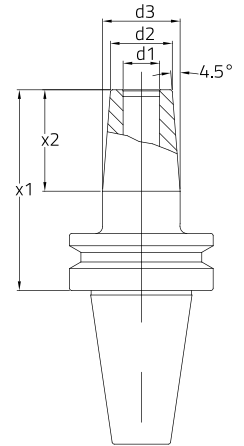

NBT40

THERMO Shrink-Fit Chuck with Internal Coolant

Code	Type	x1	d1	d2	d3	d4*	x2
NBT40-SF6C-90	Internal coolant (IKZ)	90	6	21	27	-	37
NBT40-SF6C-120	Internal coolant (IKZ)	120	6	21	27	-	37
NBT40-SF6C-160	Internal coolant (IKZ)	160	6	21	27	33.3	37
NBT40-SF6C-200	Internal coolant (IKZ)	200	6	21	27	36.1	37
NBT40-SF8C-90	Internal coolant (IKZ)	90	8	21	27	-	37
NBT40-SF8C-120	Internal coolant (IKZ)	120	8	21	27	-	37
NBT40-SF8C-160	Internal coolant (IKZ)	160	8	21	27	33.3	37
NBT40-SF8C-200	Internal coolant (IKZ)	200	8	21	27	36.1	37
NBT40-SF10C-90	Internal coolant (IKZ)	90	10	24	32	-	41
NBT40-SF10C-120	Internal coolant (IKZ)	120	10	24	32	-	41
NBT40-SF10C-160	Internal coolant (IKZ)	160	10	24	32	37.4	41
NBT40-SF10C-200	Internal coolant (IKZ)	200	10	24	32	40.2	41
NBT40-SF12C-90	Internal coolant (IKZ)	90	12	24	32	-	47
NBT40-SF12C-120	Internal coolant (IKZ)	120	12	24	32	-	47
NBT40-SF12C-160	Internal coolant (IKZ)	160	12	24	32	37.4	47
NBT40-SF12C-200	Internal coolant (IKZ)	200	12	24	32	40.2	47
NBT40-SF16C-90	Internal coolant (IKZ)	90	16	27	34	-	50
NBT40-SF16C-120	Internal coolant (IKZ)	120	16	27	34	-	50
NBT40-SF16C-160	Internal coolant (IKZ)	160	16	27	34	39.8	50
NBT40-SF16C-200	Internal coolant (IKZ)	200	16	27	34	42.6	50
NBT40-SF20C-90	Internal coolant (IKZ)	90	20	33	42	-	52
NBT40-SF20C-120	Internal coolant (IKZ)	120	20	33	42	-	52
NBT40-SF20C-160	Internal coolant (IKZ)	160	20	33	42	47	52
NBT40-SF25C-100	Internal coolant (IKZ)	100	25	44	52	-	58
NBT40-SF25C-160	Internal coolant (IKZ)	160	25	44	52	-	58

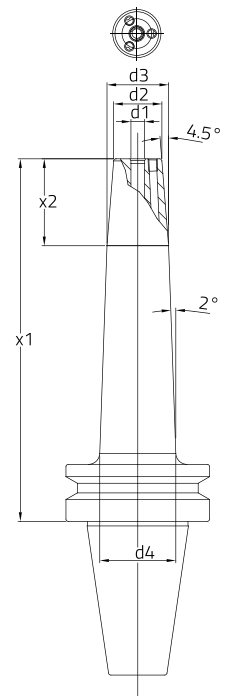

*Slope 2° is on toolholders with X1=160 and 200mm

NBT40

THERMO Shrink-Fit Chuck Slim

Code	Type	x1	d1	d2	d3	d4	x2
NBT40-SF3-90F	FORM (slim), 3 deg	90	3	9	14.8	-	-
NBT40-SF3-120F	FORM (slim), 3 deg	120	3	9	18	-	-
NBT40-SF3-160F	FORM (slim), 3 deg	160	3	9	22.1	-	-
NBT40-SF4-90F	FORM (slim), 3 deg	90	4	10	15.8	-	-
NBT40-SF4-120F	FORM (slim), 3 deg	120	4	10	19	-	-
NBT40-SF4-160F	FORM (slim), 3 deg	160	4	10	23.1	-	-
NBT40-SF6-90F	FORM (slim), 3 deg	90	6	12	17.8	-	37
NBT40-SF6-120F	FORM (slim), 3 deg	120	6	12	21	-	37
NBT40-SF6-160F	FORM (slim), 3 deg	160	6	12	25.1	-	37
NBT40-SF8-90F	FORM (slim), 3 deg	90	8	14	19.8	-	37
NBT40-SF8-120F	FORM (slim), 3 deg	120	8	14	23	-	37
NBT40-SF8-160F	FORM (slim), 3 deg	160	8	14	27.1	-	37
NBT40-SF10-90F	FORM (slim), 3 deg	90	10	16	21.8	-	41
NBT40-SF10-120F	FORM (slim), 3 deg	120	10	16	25	-	41
NBT40-SF10-160F	FORM (slim), 3 deg	160	10	16	29.1	-	41
NBT40-SF12-90F	FORM (slim), 3 deg	90	12	18	23.8	-	47
NBT40-SF12-120F	FORM (slim), 3 deg	120	12	18	27	-	47
NBT40-SF12-160F	FORM (slim), 3 deg	160	12	18	31.1	-	47

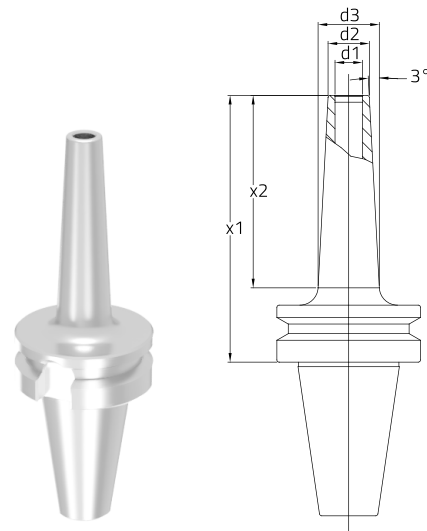

NBT50

THERMO Shrink-Fit Chuck Slim

Code	Type	x1	d1	d2	d3	d4	x2
NBT50-SF6-100F	FORM (slim), 3 deg	100	6	12	18	-	37
NBT50-SF6-130F	FORM (slim), 3 deg	130	6	12	21	-	37
NBT50-SF6-160F	FORM (slim), 3 deg	160	6	12	24	-	37
NBT50-SF8-100F	FORM (slim), 3 deg	100	8	14	20	-	37
NBT50-SF8-130F	FORM (slim), 3 deg	130	8	14	23	-	37
NBT50-SF8-160F	FORM (slim), 3 deg	160	8	14	26	-	37
NBT50-SF10-100F	FORM (slim), 3 deg	100	10	16	22	-	41
NBT50-SF10-130F	FORM (slim), 3 deg	130	10	16	25	-	41
NBT50-SF10-160F	FORM (slim), 3 deg	160	10	16	28	-	41
NBT50-SF12-100F	FORM (slim), 3 deg	100	12	18	24	-	47
NBT50-SF12-130F	FORM (slim), 3 deg	130	12	18	27	-	47
NBT50-SF12-160F	FORM (slim), 3 deg	160	12	18	30	-	47

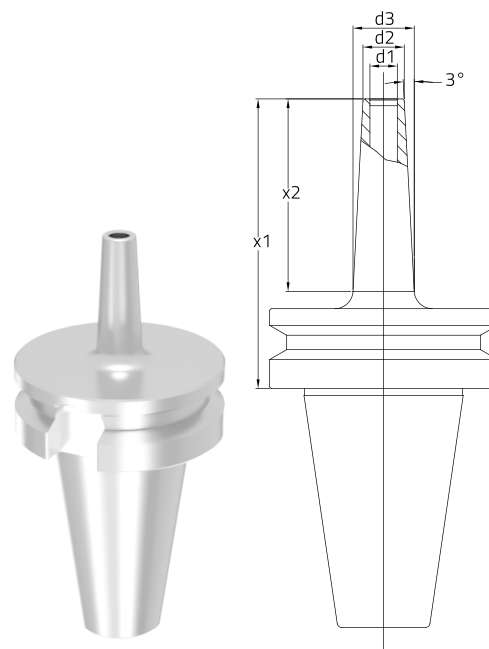

NBT50

THERMO Shrink-Fit Chuck with Internal Coolant

Code	Type	x1	d1	d2	d3	d4*	x2
NBT50-SF6C-100	Internal coolant (IKZ)	100	6	21	27	-	37
NBT50-SF6C-130	Internal coolant (IKZ)	130	6	21	27	-	37
NBT50-SF6C-160	Internal coolant (IKZ)	160	6	21	27	32.5	37
NBT50-SF6C-200	Internal coolant (IKZ)	200	6	21	27	35.3	37
NBT50-SF8C-100	Internal coolant (IKZ)	100	8	21	27	-	37
NBT50-SF8C-130	Internal coolant (IKZ)	130	8	21	27	-	37
NBT50-SF8C-160	Internal coolant (IKZ)	160	8	21	27	32.5	37
NBT50-SF8C-200	Internal coolant (IKZ)	200	8	21	27	35.3	37
NBT50-SF10C-100	Internal coolant (IKZ)	100	10	24	32	-	41
NBT50-SF10C-130	Internal coolant (IKZ)	130	10	24	32	-	41
NBT50-SF10C-160	Internal coolant (IKZ)	160	10	24	32	36.7	41
NBT50-SF10C-200	Internal coolant (IKZ)	200	10	24	32	39.4	41
NBT50-SF12C-100	Internal coolant (IKZ)	100	12	24	32	-	47
NBT50-SF12C-130	Internal coolant (IKZ)	130	12	24	32	-	47
NBT50-SF12C-160	Internal coolant (IKZ)	160	12	24	32	36.7	47
NBT50-SF12C-200	Internal coolant (IKZ)	200	12	24	32	39.4	47
NBT50-SF16C-100	Internal coolant (IKZ)	100	16	27	34	-	50
NBT50-SF16C-130	Internal coolant (IKZ)	130	16	27	34	-	50
NBT50-SF16C-160	Internal coolant (IKZ)	160	16	27	34	39.1	50
NBT50-SF16C-200	Internal coolant (IKZ)	200	16	27	34	41.9	50
NBT50-SF20C-100	Internal coolant (IKZ)	100	20	33	42	-	52
NBT50-SF20C-130	Internal coolant (IKZ)	130	20	33	42	-	52
NBT50-SF20C-160	Internal coolant (IKZ)	160	20	33	42	46.2	52
NBT50-SF20C-200	Internal coolant (IKZ)	200	20	33	42	49.0	52
NBT50-SF25C-100	Internal coolant (IKZ)	100	25	44	53	-	58
NBT50-SF25C-130	Internal coolant (IKZ)	130	25	44	53	-	58
NBT50-SF25C-160	Internal coolant (IKZ)	160	25	44	53	57.2	58
NBT50-SF25C-200	Internal coolant (IKZ)	200	25	44	53	60.0	58
NBT50-SF32C-100	Internal coolant (IKZ)	100	32	44	53	-	63
NBT50-SF32C-130	Internal coolant (IKZ)	130	32	44	53	-	63
NBT50-SF32C-160	Internal coolant (IKZ)	160	32	44	53	57.2	63
NBT50-SF32C-200	Internal coolant (IKZ)	200	32	44	53	60.0	63

*Slope 2° is on toolholders with X1=160 and 200mm

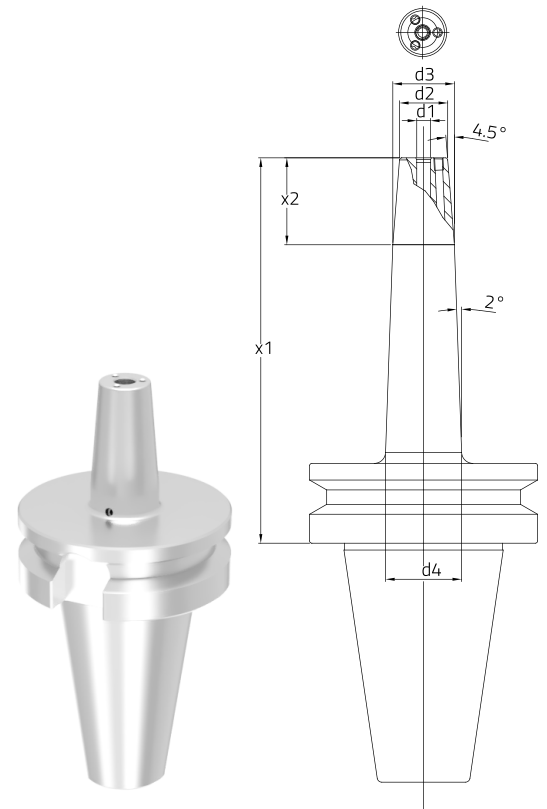

IT40

THERMO Shrink-Fit Chuck

Code	Type	x1	d1	d2	d3	d4*	x2
IT40-SF03-80	STANDARD	80	3	9	16	-	-
IT40-SF03-120	STANDARD	120	3	9	16	-	-
IT40-SF03-160	STANDARD	160	3	9	16	22.4	-
IT40-SF04-80	STANDARD	80	4	10	17	-	-
IT40-SF04-120	STANDARD	120	4	10	17	-	-
IT40-SF04-160	STANDARD	160	4	10	17	23.4	-

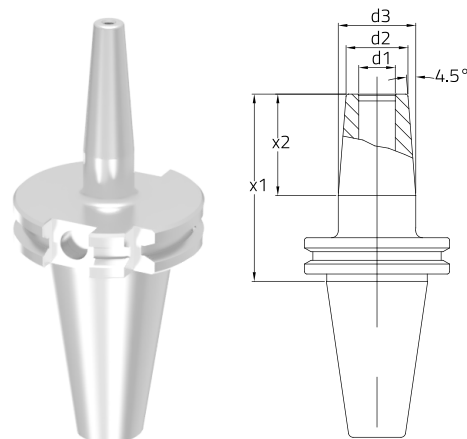

IT40

THERMO Shrink-Fit Chuck with Internal Coolant

Code	Type	x1	d1	d2	d3	d4*	x2
IT40-SF6C-80	Internal coolant (IKZ)	80	6	21	27	-	37
IT40-SF6C-120	Internal coolant (IKZ)	120	6	21	27	-	37
IT40-SF6C-160	Internal coolant (IKZ)	160	6	21	27	33.8	37
IT40-SF6C-200	Internal coolant (IKZ)	200	6	21	27	36.6	37
IT40-SF8C-80	Internal coolant (IKZ)	80	8	21	27	-	37
IT40-SF8C-120	Internal coolant (IKZ)	120	8	21	27	-	37
IT40-SF8C-160	Internal coolant (IKZ)	160	8	21	27	33.8	37
IT40-SF8C-200	Internal coolant (IKZ)	200	8	21	27	36.6	37
IT40-SF10C-80	Internal coolant (IKZ)	80	10	24	32	-	41
IT40-SF10C-120	Internal coolant (IKZ)	120	10	24	32	-	41
IT40-SF10C-160	Internal coolant (IKZ)	160	10	24	32	38	41
IT40-SF10C-200	Internal coolant (IKZ)	200	10	24	32	40.7	41
IT40-SF12C-80	Internal coolant (IKZ)	80	12	24	32	-	47
IT40-SF12C-120	Internal coolant (IKZ)	120	12	24	32	-	47
IT40-SF12C-160	Internal coolant (IKZ)	160	12	24	32	38	47
IT40-SF12C-200	Internal coolant (IKZ)	200	12	24	32	40.7	47
IT40-SF16C-80	Internal coolant (IKZ)	80	16	27	34	-	50
IT40-SF16C-120	Internal coolant (IKZ)	120	16	27	34	-	50
IT40-SF16C-160	Internal coolant (IKZ)	160	16	27	34	40.4	50
IT40-SF16C-200	Internal coolant (IKZ)	200	16	27	34	43.2	50
IT40-SF20C-80	Internal coolant (IKZ)	80	20	33	42	-	52
IT40-SF20C-120	Internal coolant (IKZ)	120	20	33	42	-	52
IT40-SF20C-160	Internal coolant (IKZ)	160	20	33	42	47.6	52
IT40-SF25C-100	Internal coolant (IKZ)	100	25	44	53	-	58
IT40-SF25C-160	Internal coolant (IKZ)	160	25	44	53	-	58

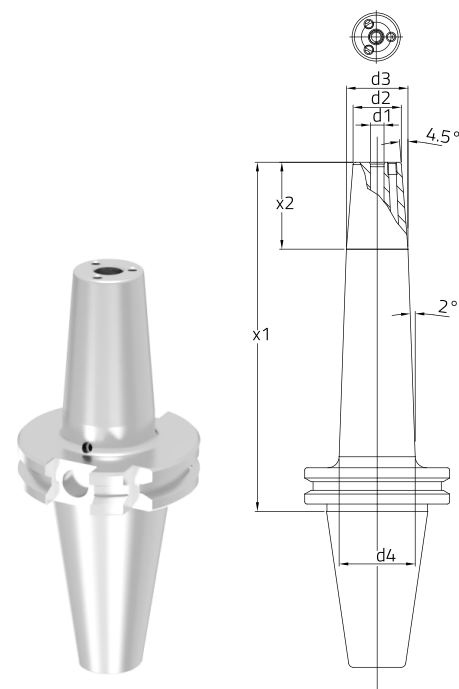

IT40

THERMO Shrink-Fit Chuck Slim

Code	Type	x1	d1	d2	d3	d4	x2
IT40-SF3-80F	FORM (slim), 3 deg.	80	3	9	14.6	-	-
IT40-SF3-120F	FORM (slim), 3 deg.	120	3	9	18.8	-	-
IT40-SF3-160F	FORM (slim), 3 deg.	160	3	9	23	-	-
IT40-SF4-80F	FORM (slim), 3 deg.	80	4	10	15.6	-	-
IT40-SF4-120F	FORM (slim), 3 deg.	120	4	10	19.8	-	-
IT40-SF4-160F	FORM (slim), 3 deg.	160	4	10	24	-	-
IT40-SF6-80F	FORM (slim), 3 deg.	80	6	12	17.6	-	37
IT40-SF6-120F	FORM (slim), 3 deg.	120	6	12	21.8	-	37
IT40-SF6-160F	FORM (slim), 3 deg.	160	6	12	26	-	37
IT40-SF8-80F	FORM (slim), 3 deg.	80	8	14	19.6	-	37
IT40-SF8-120F	FORM (slim), 3 deg.	120	8	14	23.8	-	37
IT40-SF8-160F	FORM (slim), 3 deg.	160	8	14	28	-	37
IT40-SF10-80F	FORM (slim), 3 deg.	80	10	16	21.6	-	41
IT40-SF10-120F	FORM (slim), 3 deg.	120	10	16	25.8	-	41
IT40-SF10-160F	FORM (slim), 3 deg.	160	10	16	30	-	41
IT40-SF12-80F	FORM (slim), 3 deg.	80	12	18	23.6	-	47
IT40-SF12-120F	FORM (slim), 3 deg.	120	12	18	27.8	-	47
IT40-SF12-160F	FORM (slim), 3 deg.	160	12	18	32	-	47

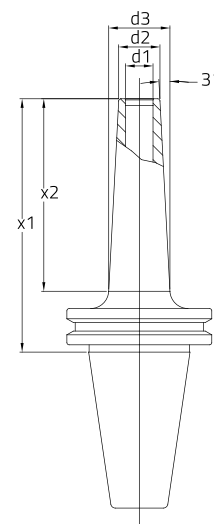

IT50

THERMO Shrink-Fit Chuck Slim

Code	Type	x1	d1	d2	d3	d4	x2
IT50-SF6-80F	FORM (slim), 3 deg.	80	6	12	17.6	-	37
IT50-SF6-120F	FORM (slim), 3 deg.	120	6	12	21.8	-	37
IT50-SF6-160F	FORM (slim), 3 deg.	160	6	12	26	-	37
IT50-SF8-80F	FORM (slim), 3 deg.	80	8	14	19.6	-	37
IT50-SF8-120F	FORM (slim), 3 deg.	120	8	14	23.8	-	37
IT50-SF8-160F	FORM (slim), 3 deg.	160	8	14	28	-	37
IT50-SF10-80F	FORM (slim), 3 deg.	80	10	16	21.6	-	41
IT50-SF10-120F	FORM (slim), 3 deg.	120	10	16	25.8	-	41
IT50-SF10-160F	FORM (slim), 3 deg.	160	10	16	30	-	41
IT50-SF12-80F	FORM (slim), 3 deg.	80	12	18	23.6	-	47
IT50-SF12-120F	FORM (slim), 3 deg.	120	12	18	27.8	-	47
IT50-SF12-160F	FORM (slim), 3 deg.	160	12	18	32	-	47

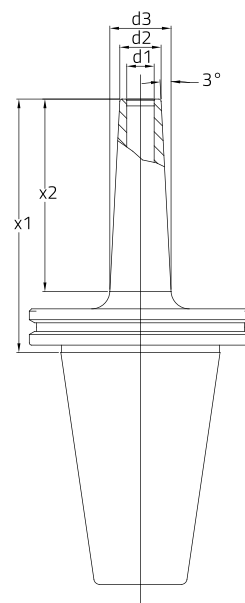

IT50

THERMO Shrink-Fit Chuck with Internal Coolant

Code	Type	x1	d1	d2	d3	d4*	x2
IT50-SF6C-80	Internal coolant (IKZ)	80	6	21	27	-	37
IT50-SF6C-120	Internal coolant (IKZ)	120	6	21	27	-	37
IT50-SF6C-160	Internal coolant (IKZ)	160	6	21	27	33.8	37
IT50-SF6C-200	Internal coolant (IKZ)	200	6	21	27	36.6	37
IT50-SF8C-80	Internal coolant (IKZ)	80	8	21	27	-	37
IT50-SF8C-120	Internal coolant (IKZ)	120	8	21	27	-	37
IT50-SF8C-160	Internal coolant (IKZ)	160	8	21	27	33.8	37
IT50-SF8C-200	Internal coolant (IKZ)	200	8	21	27	36.6	37
IT50-SF10C-80	Internal coolant (IKZ)	80	10	24	32	-	41
IT50-SF10C-120	Internal coolant (IKZ)	120	10	24	32	-	41
IT50-SF10C-160	Internal coolant (IKZ)	160	10	24	32	38	41
IT50-SF10C-200	Internal coolant (IKZ)	200	10	24	32	40.7	41
IT50-SF12C-80	Internal coolant (IKZ)	80	12	24	32	-	47
IT50-SF12C-120	Internal coolant (IKZ)	120	12	24	32	-	47
IT50-SF12C-160	Internal coolant (IKZ)	160	12	24	32	38	47
IT50-SF12C-200	Internal coolant (IKZ)	200	12	24	32	40.7	47
IT50-SF16C-80	Internal coolant (IKZ)	80	16	27	34	-	50
IT50-SF16C-120	Internal coolant (IKZ)	120	16	27	34	-	50
IT50-SF16C-160	Internal coolant (IKZ)	160	16	27	34	40.4	50
IT50-SF16C-200	Internal coolant (IKZ)	200	16	27	34	43.2	50
IT50-SF20C-80	Internal coolant (IKZ)	80	20	33	42	-	52
IT50-SF20C-120	Internal coolant (IKZ)	120	20	33	42	-	52
IT50-SF20C-160	Internal coolant (IKZ)	160	20	33	42	47.6	52
IT50-SF20C-200	Internal coolant (IKZ)	200	20	33	42	50.3	52
IT50-SF25C-100	Internal coolant (IKZ)	100	25	44	53	-	58
IT50-SF25C-120	Internal coolant (IKZ)	120	25	44	53	-	58
IT50-SF25C-160	Internal coolant (IKZ)	160	25	44	53	58.5	58
IT40-SF25C-200	Internal coolant (IKZ)	200	25	44	53	61.3	58
IT40-SF32C-100	Internal coolant (IKZ)	100	32	44	53	-	63
IT40-SF32C-120	Internal coolant (IKZ)	120	32	44	53	-	63
IT40-SF32C-160	Internal coolant (IKZ)	160	32	44	53	58.5	63
IT40-SF32C-200	Internal coolant (IKZ)	200	32	44	53	61.3	63

*Slope 2° is on toolholders with X1=160 and 200mm

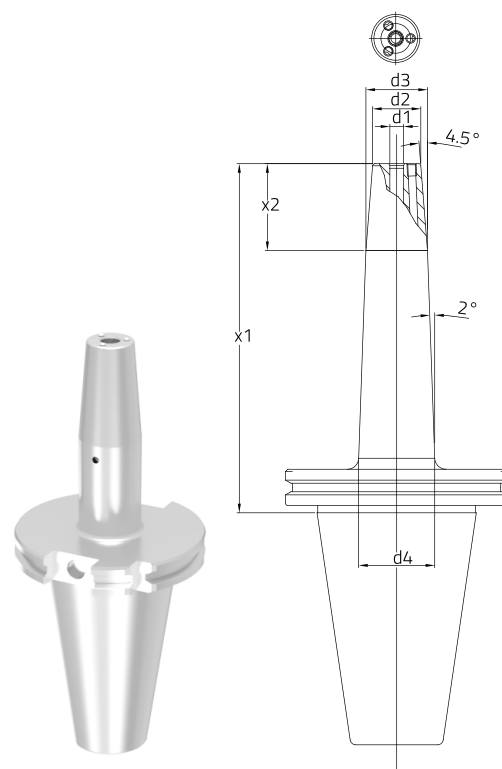

HSK63A

THERMO Shrink-Fit Chuck

Code	Type	x1	d1	d2	d3	d4*	x2
HSK63A-SF3-80	STANDARD	80	3	9	16	-	-
HSK63A-SF3-120	STANDARD	120	3	9	16	-	-
HSK63A-SF3-160	STANDARD	160	3	9	16	21.9	-
HSK63A-SF4-80	STANDARD	80	4	10	17	-	-
HSK63A-SF4-120	STANDARD	120	4	10	17	-	-
HSK63A-SF4-160	STANDARD	160	4	10	17	22.9	-

*Slope 2° is on toolholders with X1=160 and 200mm

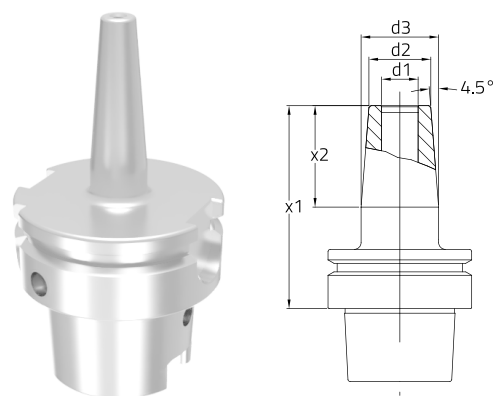

HSK63A

THERMO Shrink-Fit Slim

Code	Type	x1	d1	d2	d3	d4	x2
HSK63A-SF3-80F	FORM (Slim), 3 deg.	80	3	9	13.9	-	-
HSK63A-SF3-120F	FORM (Slim), 3 deg.	120	3	9	18.1	-	-
HSK63A-SF3-160F	FORM (Slim), 3 deg.	160	3	9	22.3	-	-
HSK63A-SF4-80F	FORM (Slim), 3 deg.	80	4	10	14.9	-	-
HSK63A-SF4-120F	FORM (Slim), 3 deg.	120	4	10	19.1	-	-
HSK63A-SF4-160F	FORM (Slim), 3 deg.	160	4	10	23.3	-	-
HSK63A-SF6-80F	FORM (Slim), 3 deg.	80	6	12	16.9	-	37
HSK63A-SF6-120F	FORM (Slim), 3 deg.	120	6	12	21.1	-	37
HSK63A-SF6-160F	FORM (Slim), 3 deg.	160	6	12	25.3	-	37
HSK63A-SF8-80F	FORM (Slim), 3 deg.	80	8	14	18.9	-	37
HSK63A-SF8-120F	FORM (Slim), 3 deg.	120	8	14	23.1	-	37
HSK63A-SF8-160F	FORM (Slim), 3 deg.	160	8	14	27.3	-	37
HSK63A-SF10-85F	FORM (Slim), 3 deg.	85	10	16	21.4	-	41
HSK63A-SF10-120F	FORM (Slim), 3 deg.	120	10	16	25.1	-	41
HSK63A-SF10-160F	FORM (Slim), 3 deg.	160	10	16	29.3	-	41
HSK63A-SF12-90F	FORM (Slim), 3 deg.	90	12	18	23.9	-	47
HSK63A-SF12-120F	FORM (Slim), 3 deg.	120	12	18	27.1	-	47
HSK63A-SF12-160F	FORM (Slim), 3 deg.	160	12	18	31.3	-	47

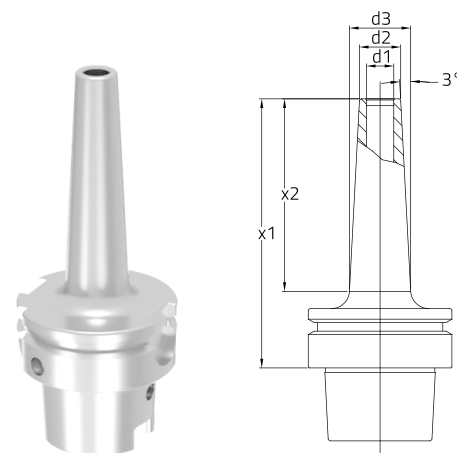

HSK63A

THERMO Shrink-Fit with Internal Coolant

Code	Type	x1	d1	d2	d3	d4*	x2
HSK63A-SF6C-80	Internal coolant (IKZ)	80	6	21	27	-	37
HSK63A-SF6C-120	Internal coolant (IKZ)	120	6	21	27	-	37
HSK63A-SF6C-160	Internal coolant (IKZ)	160	6	21	27	33.4	37
HSK63A-SF6C-200	Internal coolant (IKZ)	200	6	21	27	36.2	37
HSK63A-SF8C-80	Internal coolant (IKZ)	80	8	21	27	-	37
HSK63A-SF8C-120	Internal coolant (IKZ)	120	8	21	27	-	37
HSK63A-SF8C-160	Internal coolant (IKZ)	160	8	21	27	33.4	37
HSK63A-SF8C-200	Internal coolant (IKZ)	200	8	21	27	36.2	37
HSK63A-SF10C-85	Internal coolant (IKZ)	85	10	24	32	-	41
HSK63A-SF10C-120	Internal coolant (IKZ)	120	10	24	32	-	41
HSK63A-SF10C-160	Internal coolant (IKZ)	160	10	24	32	37.5	41
HSK63A-SF10C-200	Internal coolant (IKZ)	200	10	24	32	40.3	41
HSK63A-SF12C-90	Internal coolant (IKZ)	90	12	24	32	-	47
HSK63A-SF12C-120	Internal coolant (IKZ)	120	12	24	32	-	47
HSK63A-SF12C-160	Internal coolant (IKZ)	160	12	24	32	37.5	47
HSK63A-SF12C-200	Internal coolant (IKZ)	200	12	24	32	40.3	47
HSK63A-SF16C-95	Internal coolant (IKZ)	95	16	27	34	-	50
HSK63A-SF16C-120	Internal coolant (IKZ)	120	16	27	34	-	50
HSK63A-SF16C-160	Internal coolant (IKZ)	160	16	27	34	39.9	50
HSK63A-SF16C-200	Internal coolant (IKZ)	200	16	27	34	42.7	50
HSK63A-SF20C-100	Internal coolant (IKZ)	100	20	33	42	-	52
HSK63A-SF20C-120	Internal coolant (IKZ)	120	20	33	42	-	52
HSK63A-SF20C-160	Internal coolant (IKZ)	160	20	33	42	47	52
HSK63A-SF25C-115	Internal coolant (IKZ)	115	25	44	52	-	58
HSK63A-SF25C-160	Internal coolant (IKZ)	160	25	44	52	-	58

*Slope 2° is on toolholders with X1=160 and 200mm

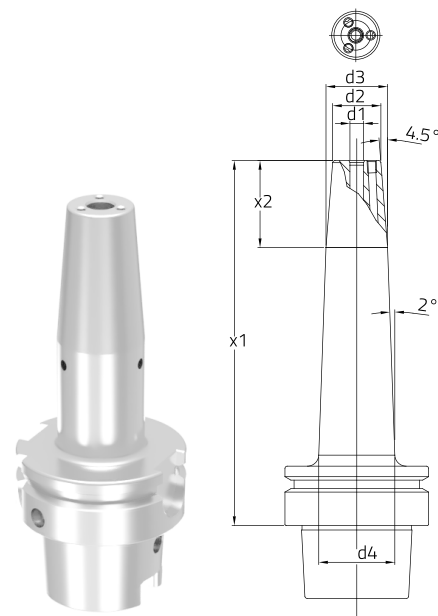

HSK100A

THERMO Shrink-Fit with Internal Coolant

Code	Type	x1	d1	d2	d3	d4	x2
HSK100A-SF6C-085	Internal coolant (IKZ)	85	6	21	27	-	37
HSK100A-SF6C-130	Internal coolant (IKZ)	130	6	21	27	-	37
HSK100A-SF6C-160	Internal coolant (IKZ)	160	6	21	27	32.8	37
HSK100A-SF6C-200	Internal coolant (IKZ)	200	6	21	27	35.6	37
HSK100A-SF8C-085	Internal coolant (IKZ)	85	8	21	27	-	37
HSK100A-SF8C-130	Internal coolant (IKZ)	130	8	21	27	-	37
HSK100A-SF8C-160	Internal coolant (IKZ)	160	8	21	27	32.8	37
HSK100A-SF8C-200	Internal coolant (IKZ)	200	8	21	27	35.6	37
HSK100A-SF10C-090	Internal coolant (IKZ)	90	10	24	32	-	41
HSK100A-SF10C-130	Internal coolant (IKZ)	130	10	24	32	-	41
HSK100A-SF10C-160	Internal coolant (IKZ)	160	10	24	32	37.1	41
HSK100A-SF10C-200	Internal coolant (IKZ)	200	10	24	32	39.9	41
HSK100A-SF12C-095	Internal coolant (IKZ)	95	12	24	32	-	47
HSK100A-SF12C-130	Internal coolant (IKZ)	130	12	24	32	-	47
HSK100A-SF12C-160	Internal coolant (IKZ)	160	12	24	32	37.1	47
HSK100A-SF12C-200	Internal coolant (IKZ)	200	12	24	32	39.9	47
HSK100A-SF16C-100	Internal coolant (IKZ)	100	16	27	34	-	50
HSK100A-SF16C-130	Internal coolant (IKZ)	130	16	27	34	-	50
HSK100A-SF16C-160	Internal coolant (IKZ)	160	16	27	34	39.5	50
HSK100A-SF16C-200	Internal coolant (IKZ)	200	16	27	34	42.3	50
HSK100A-SF20C-105	Internal coolant (IKZ)	105	20	33	42	-	52
HSK100A-SF20C-130	Internal coolant (IKZ)	130	20	33	42	-	52
HSK100A-SF20C-160	Internal coolant (IKZ)	160	20	33	42	46.6	52
HSK100A-SF20C-200	Internal coolant (IKZ)	200	20	33	42	49.4	52
HSK100A-SF25C-115	Internal coolant (IKZ)	115	25	44	53	-	58
HSK100A-SF25C-160	Internal coolant (IKZ)	160	25	44	53	57.8	58
HSK100A-SF25C-200	Internal coolant (IKZ)	200	25	44	53	60.6	58
HSK100A-SF32C-120	Internal coolant (IKZ)	120	32	44	53	-	63
HSK100A-SF32C-160	Internal coolant (IKZ)	160	32	44	53	57.8	63
HSK100A-SF32C-200	Internal coolant (IKZ)	200	32	44	53	60.6	63

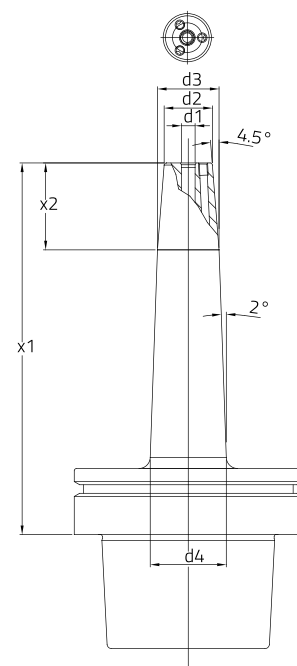



The Spirit of Innovation

NIKKEN eu

NIKKEN Innovation Centre Europe

Advanced Manufacturing Park, Brindley Way,
Catcliffe, Rotherham, S60 5FS, UK

t: +44 (0)1709 366306 | f: +44 (0)1709 376683

e: info@nikken-world.com | w: www.nikken-world.com