

Zero Fit Holder

PAT.P

- Better Milling with High Quality Surface Finish.
- Better and Stable Finish Tolerance for Machining Holes.
- Extended Tool Life.
- Wide Adjustable Range for Run-out Error.
Simple, Quick and Secure Operation

New technology with intensified cam + Ball system

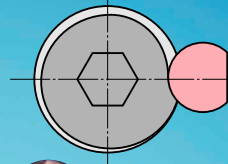

Wide adjustment range
Fine adjustment.



NIKKEN ZERO FIT HOLDER

“0” Fit with Accurate, Quick and Simple Operation.



When the machine has been used for 2~3 years, the run-out accuracy of the spindle will be declining with accuracy of 0.01mm~0.04mm at 100mm from the gauge line, the Zero Fit Holder allows correction of this error back to the run-out of 0.001~0.002mm.



At Machine Spindle

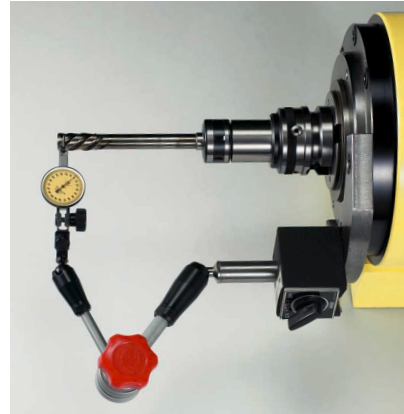

At Tool Presetter

With “0” Fitting the Tool Run-out Accuracy;

- The milling surface finish and quality can be improved.
- The finish hole size tolerance can be improved and stable.
- The tool life can be extended.

Fig.1 shows the relation between run-out accuracy and tool life, and when the run-out accuracy of 21 microns is reduced to 3 microns, the tool life can be improved by approximately 5 times.

- Zero Fit Holder has wide adjustment range compared with competitors equivalent, and its mechanism performs simple, quick and secured operation.

- The choice of the Slim Chuck style “SZF” & the Anniversary type Milling Chuck style “CZF” can be selected dependant on your cutter.

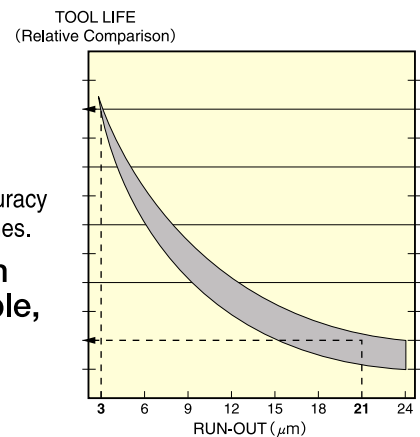

Fig.1

SZF Style : SZF6, SZF10, SZF16 & SZF25 to hold 0.7~25.4mm



- Please use High Precision type P-class collet or A-type collet.
- Please use SK J type nut & cap for centre through coolant. The nut & cap also prevents from contamination of fine swarf and dust into the collet, thus the accuracy can be retained for long-term use.

CZF Style : CZF20, CZF25 & CZF32 to hold 2~32mm



- For centre through coolant use without collet, please use CKFN-D nut.
- When the collet is required to use with, please use the CCK Collet and CKFN Nut. The nut & cap also prevents from contamination of fine swarf and dust into the collet, thus the accuracy can be retained for long-term use.



CKFN-D Nut
Direct setting on to cutter shank.

Standard Front Nut
CKFN



The jet coolant pressure creates a tornado effect, ensuring efficient swarf dispersal.

Front Nut with O-ring
CKFN-C



This front nut has O-ring fitted at the internal diameter for the cutter with coolant hole.

Front Nut with multi nozzle
CKFN-MN



This front nut has multi nozzle for the cutter that has larger front end diameter than its shank diameter.

CCK Collet



8,000min⁻¹

High speed rotation creates tornado effect

JAPAN PAT.P

NIKKEN ZERO FIT HOLDER "0" Fit with Accurate, Quick and Simple Operation.



For better surface finish and quality at milling operation

...The milling surface finish can be substantially improved.

Material : Pre-Hardened Steel NAK55 (HRC40)

End Mill : $\phi 16\text{mm}$, 4 teeth Carbide
 Cutting Speed : $V=180\text{m/min}$.
 Spindle Rotation : $S=3,600\text{ min}^{-1}$
 Feed per tooth : $f=0.1\text{mm/tooth}$
 Feed : $F=1,440\text{mm/min}$.

Material : Carbon Steel C55

End Mill : $\phi 16\text{mm}$, 4 teeth Carbide
 Cutting Speed : $V=150\text{m/min}$.
 Spindle Rotation : $S=3,000\text{ min}^{-1}$
 Feed per tooth : $f=0.1\text{mm/tooth}$
 Feed : $F=1,200\text{mm/min}$.

After Zero Fitting :

Run-out at cutter front edge = 1 micron
 Rmax = 2 microns

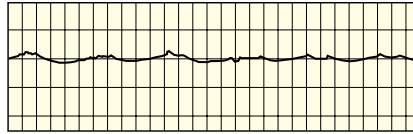

Before Zero Fitting :

Run-out at cutter front edge = 18 microns
 Rmax = 5.6 microns

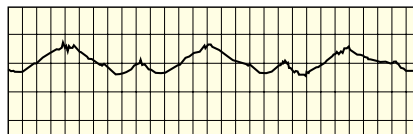

After Zero Fitting :

Run-out at cutter front edge = 1 micron
 Rmax = 2.7 microns

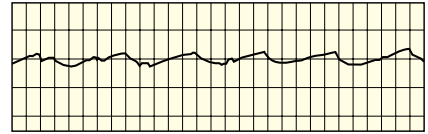

Before Zero Fitting :

Run-out at cutter front edge = 18 microns
 Rmax = 9.6 microns

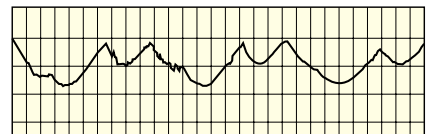

Materials : Pre-Hardened Steel NAK55 (HRC39)
 End Mill : 10mm, 2 teeth Carbide Ball End Mill
 Cutting Speed : $V=200\text{m/min}$
 Spindle Rotation : $S=6,366\text{min}^{-1}$
 Feed per tooth : $f=0.15\text{mm/min}$
 Feed : $F=1,910\text{mm/min}$
 Dry Cutting with Air blow

Before Zero Fitting :
 Run-out at cutter front edge = 20 microns



After Zero Fitting :
 Run-out at cutter front edge = 1 micron

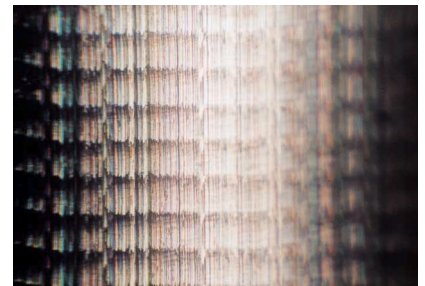

For better and stable finish tolerance for machining holes

...The variation at finish tolerance can be minimized, thus the finish size tolerance can be reduced.



Materials : Tempered Steel
 Tool : $\phi 13\text{mm}$ CBN Reamer
 Cutting Speed : $V=80\text{m/min}$
 Spindle Rotation : $S=2,000\text{min}^{-1}$
 Feed per tooth : $f=0.1\text{mm/min}$
 Feed : $F=200\text{mm/min}$
 External coolant supply : Water soluble.

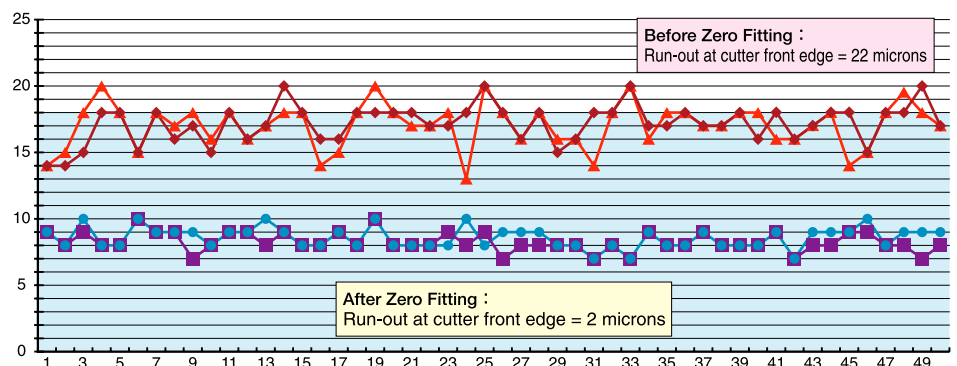
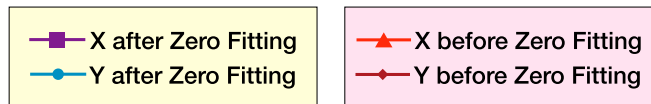
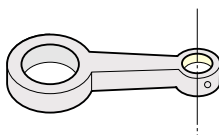

ZERO FIT TYPE MILLING CHUCK



Fig.1

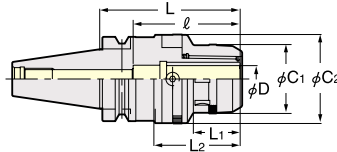
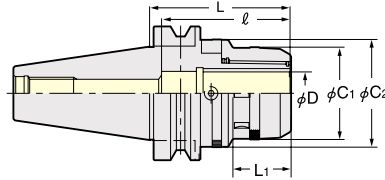

Fig.2



Explanation of the Code No.

BT40 **CZF32** - **120**

- Nominal Gauge Length
- Chucking Capacity
- Zero Fit Type Milling Chuck
- Shank No.

BT-CZF

TAPER	Code No.	C1	C2	L	L1	L2	l	Weight (Kg)	Fig.	Collet
30	BT30-CZF20-100	51.5	66.5	100	35	68	80	1.5	1	KM20, CCK20
	-CZF25-100	59.5	74.5	100	35	68	80	1.6		KM25, CCK25
40	BT40-CZF20-105, 120	51.5	66.5	105, 120	35	64.5	80	2.1, 2.5		KM20, CCK20
	-CZF25-105, 120	59.5	74.5	105, 120	35	68	80	2.4, 2.9		KM25, CCK25
	-CZF32-120	69	80.5	120	42	78	105	2.8		KM32, CCK32
50	BT50-CZF20-105, 165	51.5	66.5	105, 165	35	-	80	4.6, 6.0		2
	-CZF25-105, 165	59.5	74.5	105, 165	35	-	80	5.0, 6.8	KM25, CCK25	
	-CZF32-105, 165	69	80.5	105, 165	42	-	105	5.3, 7.4	KM32, CCK32	

IT-CZF

TAPER	Code No.	C1	C2	L	L1	L2	l	Weight (Kg)	Fig.	Collet
40	IT40-CZF20-105	51.5	66.5	105	35	70	80	2.1	1	KM20, CCK20
	-CZF25-105	59.5	74.5	105	35	70	80	2.4		KM25, CCK25
	-CZF32-120	69	80.5	120	42	85	105	2.8		KM32, CCK32
50	IT50-CZF20-105	51.5	66.5	105	35	-	80	4.7	2	KM20, CCK20
	-CZF25-105	59.5	74.5	105	35	-	80	5		KM25, CCK25
	-CZF32-120	69	80.5	120	42	-	105	5.3		KM32, CCK32

★Spanner is available as an option.

CZF20 type : 9HC22, CZF25 type : 9HC25, CZF32 type : 9HC32

★Spanner for run-out adjustment (9ZF) is available as an option.

★Please note that the acceptable shank tolerance is h6~h7.

★Please add "P" at the end of Code No. for the high speed type. e.g. BT40-CZF25-105P

★For centre through coolant use without collet, please use CCKFN-D Nut.

When the collet is required to use with, please use the CCK Collet and CCKFN Nut.

Wrench to adjust
9ZF



NEW



CCKFN20-20D
CCKFN25-25D
CCKFN32-32D



Straight Collet



Photo shows Anniversary Type KM Collet.

Style	KM Collet Code No.(OD-ID)
(KM20)	KM20 -2, 3, 4, 5, 6, 7, 8, 9, 10, 11, 12, 13, 14, 15, 16
(KM25)	KM25 -3, 4, 5, 6, 7, 8, 9, 10, 11, 12, 13, 14, 15, 16, 17, 18, 19, 20, 21, 22
(KM32)	KM32 -3, 4, 5, 6, 7, 8, 9, 10, 11, 12, 13, 14, 15, 16, 17, 18, 19, 20, 21, 22, 23, 24, 25, 26

★The Collets with bold character are the "ANNIVERSARY" type (N) KM collet.

★Please note that the acceptable shank tolerance is h6~h7.

KM

Explanation of the Code No.

CCK **32** - **10**

- ID of Collet
- OD of Collet
- Symbol of CCK Collet

CCK : Centre Coolant
CCNK : Centre Coolant, Adjustable
KM : Standard

Centre Coolant Collet

Front Nut and CCKL Spanner are supplied as an option.



Photo. shows with front nut.

The internal helical groove for oil drain purposes prevents cutter slippage.



Photo. shows with front nut.

JAPAN PAT.P

Cutter length adjustment on the collet is possible from both front and back end side.

CCK

Style	CCK Collet Code No.(OD-ID)	Front Nut Code No.
(CCK20)	CCK20 -6, 8, 10, 12, 16	CKFN20
(CCK25)	CCK25 -6, 8, 10, 12, 16, 20	CKFN25
(CCK32)	CCK32 -6, 8, 10, 12, 16, 20, 25	CKFN32, CKFN32T

★Above bold figures indicate "ANNIVERSARY" type (N) CCK Collet.

★Please note the acceptable shank tolerance is h6~h7.

CCNK

Style	CCK Collet Code No.(OD-ID)	Front Nut Code No.
(CCNK20)	CCNK20 -6, 8, 10, 12, 16	CKFN20
(CCNK25)	CCNK25 -6, 8, 10, 12, 16, 20	CKFN25
(CCNK32)	CCNK32 -6, 8, 10, 12, 16, 20, 25	CKFN32, CKFN32T

★Please note the acceptable shank tolerance is h6~h7.

Front Nut CKFN (with 3 jet coolant grooves)



Explanation of the Code No.

CKFN **32** - **10**

- ID of Collet
- OD of Collet
- Symbol of Front Nut

Style	phi D2	L2	Front Nut Code No.
(CKFN20)	33	8	CKFN20 -6, 8, 10, 12, 16
(CKFN25)	39	8.5	CKFN25 -6, 8, 10, 12, 16, 20
(CKFN32)	46.5	9	CKFN32 -6, 8, 10, 12, 16, 20, 25

★Spanner is supplied as an option. CKFN20 : CCKL20, CKFN25 : CCKL25, CKFN32 : CCKL32

NEW



★Jet Coolant Nut with Multi Nozzle for the cutter which has larger front end diameter than its shank diameter is also available. e.g. CCKFN25-20MN 32-25MN



★Jet Coolant Nut with O-ring fitted at the internal diameter for the cutter with coolant hole is also available. e.g. CCKFN32-10C

ZERO FIT TYPE SLIM CHUCK

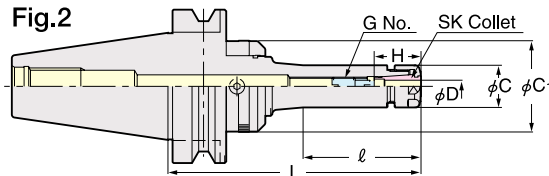
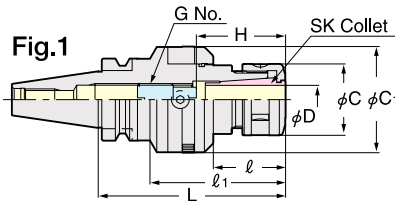

Explanation of the Code No.

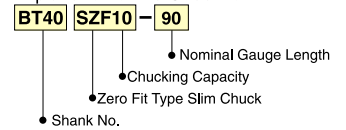

BT-SZF

TAPER	Code No.	D	L	ℓ	ℓ ₁	C	C ₁	H	G No.	Weight (Kg)	Fig.	Collet
30	BT30-SZF 6- 90	0.7~6.0	90	42	-	19.5	40.5	21~35	SKG- 8	0.9	2	SK 6
	-SZF10- 90	1.75~10.0	90	35	61	27.5	48.5	30~50	SKG-12L	1.3	1	SK10
	-SZF16-105	2.75~16.0	105	40	76	40	59.5	45~65	SKG-18L	1.6	1	SK16
40	BT40-SZF 6- 90,150	0.7~6.0	90, 150	37, 60	-	19.5	40.5, 48.5	21~35	SKG- 8	1.3, 1.7	2	SK 6
	-SZF10- 90,150	1.75~10.0	90, 150	37, 97	-	27.5	48.5	30~50	SKG-12L	1.5, 1.9	2	SK10
	-SZF16- 90,150	2.75~16.0	90, 150	37, 97	-	40	59.5	40~70	SKG-18L	1.8, 2.2	2	SK16
	-SZF25-120,150	16.0~25.4	120, 150	55, 86	84, 114	55	66.5	55~85	SKG-28	2.4, 2.9	1	SK25
50	BT50-SZF 6-105,165	0.7~6.0	105, 165	41, 63	-	19.5	40.5, 59.5	21~35	SKG- 8	4.0, 4.2	2	SK 6
	-SZF10-105,165	1.75~10.0	105, 165	41, 101	-	27.5	48.5	30~50	SKG-12L	4.5, 4.9	2	SK10
	-SZF16-105,165	2.75~16.0	105, 165	41, 101	-	40	59.5	40~70	SKG-18L	5.0, 5.4	2	SK16
	-SZF25-135,165	16.0~25.4	135, 165	71, 101	-	55	66.5	55~85	SKG-28	5.8, 6.0	2	SK25

IT-SZF

TAPER	Code No.	D	L	ℓ	ℓ ₁	C	C ₁	H	G No.	Weight (Kg)	Fig.	Collet
40	IT40-SZF 6- 90, 150	0.7~6.0	90, 150	45, 89	-	19.5	40.5	21~35	SKG- 8	1.3, 1.7	2	SK 6
	-SZF10-120, 150	1.75~10.0	120, 150	57, 87	-	27.5	48.5	30~50	SKG-12L	1.6, 1.9	2	SK10
	-SZF16-120, 150	2.75~16.0	120, 150	51, 81	-	40	59.5	40~70	SKG-18L	1.9, 2.2	2	SK16
	-SZF25-120, 150	16.0~25.4	120, 150	49, 79	85, 115	55	66.5	55~85	SKG-28	2.4, 2.9	1	SK25
50	IT50-SZF 6-105, 165	0.7~6.0	105, 165	60, 67	-	19.5	40.5, 59.5	21~35	SKG- 8	4.0, 4.2	2	SK 6
	-SZF10-105, 165	1.75~10.0	105, 165	60, 65	-	27.5	48.5, 59.5	30~50	SKG-12L	4.5, 4.9	2	SK10
	-SZF16-105, 165	2.75~16.0	105, 165	60, 120	-	40	59.5	40~70	SKG-18L	5.0, 5.4	2	SK16
	-SZF25-120, 165	16.0~25.4	120, 165	75, 120	-	55	66.5	55~85	SKG-28	5.7, 6.0	2	SK25

★SK nut, adjust screw (G No.) and collet extractor are supplied as standard. Run-out adjust spanner (9ZF1) and SKL spanner are available as option.

The code No. for SKL Spanner : SZF6 type : SKL-6W, SZF10 type : SKL-10, SZF16 type : 9HC16, SZF25 type : 9HC22

★Please use "P" class or "A" type SK collet.

★Please add "P" at the end of Code No. for the high speed type. e.g. BT40-SZF10-90P

★For centre through coolant application please use SK J type nut and cap for your preference. Please note that the length of J type nut is 6mm longer than the standard SK nut.



SK Collet

P class · A type

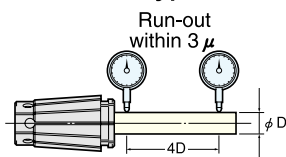

SK Collet Code No.

SK 6 - 0.8, 1, 1.25, 1.5, 1.75, 2, 2.25, 2.5, 2.75, 3 , 3.5, 4 , 4.5, 5 , 5.5, 6
SK 10 - 2, 2.25, 2.5, 2.75, 3 , 3.5, 4 , 4.5, 5 , 5.5, 6 , 6.5, 7, 7.5, 8 , 8.5, 9, 9.5, 10
SK 16 - 3, 3.5, 4, 4.5, 5, 5.5, 6, 6.5, 7, 7.5, 8, 8.5, 9, 9.5, 10 , 10.5, 11, 11.5, 12 , 12.5, 13, 13.5, 14, 14.5, 15, 15.5, 16
SK 25 - 16.5, 17, 17.5, 18, 18.5, 19, 19.5, 20 , 20.5, 21, 21.5, 22, 22.5, 23, 23.5, 24, 24.5, 25

★The gripping range of SK6-0.8~SK6-1.25 is 0.1mm. The gripping range of SK6-1.5~SK6-3 is 0.2mm.
 The gripping range of SK10-2~SK10-3 is 0.25mm. The gripping range of SK16-3 is 0.25mm. The gripping range of all other sizes is 0.5mm.
 ★ "P" class high precision (run-out accuracy of 3 microns) SK collet is also available. e.g. Code No. is SK10-3P.
 ★ "A" type collet (bold character) is also available. Please note that the acceptable shank tolerance is h8. e.g. code No. is SK10-3A.

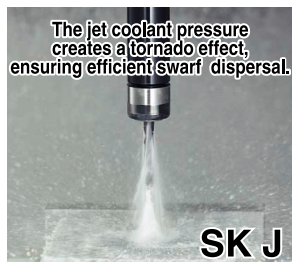

SK J

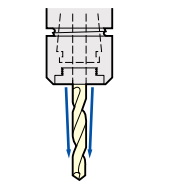

For Standard Drill

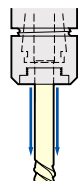

For Reamer

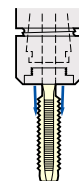

For Tap

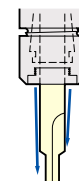

For Special Cutter

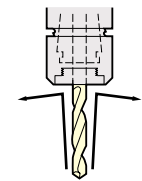

For prevention of swarf and dust contamination.

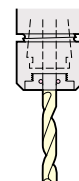

The cap with O-ring seal for using of oil hole drill is also available.

J type SK nut & cap can be used for standard Slim Chuck · SK Collet.

JAPAN PAT.P



Cap



Jet Coolant



J type Nut

Prevention of Swarf entering the collet through the slots.

SLIM CHUCK TYPE	J type Nut Code No.	Cap Code No.	WRENCH Code No.
SK 6	SKN- 6WJ	SKJ 6-3, 3.3, 4, 4.2, 5, 6	SKJL- 6
SK 10	SKN-10J	SKJ10-3, 4, 5, 5.5, 6, 6.2, 7, 8, 8.5, 10	SKJL-10
SK 16	SKN-16J	SKJ16-7, 8, 8.5, 10, 12, 12.5, 14, 15, 16	SKJL-16
SK 25	SKN-25J	SKJ25-16, 17.5, 20, 25	SKJL-25

★Please add "C" at the end of Code No. for the Cap with O-ring. e.g. SKJ10-6C.

★J type nut and cap is also suitable for prevention of the swarf and dust contamination, even without centre through coolant application.

★The special internal diameter caps are also available. Please contact us for information.

★When J type nut is used for coolant through, please remove standard adjust screw or use special adjust screw with "J"



3LOCK ZERO FIT TYPE MILLING CHUCK



Fig.1

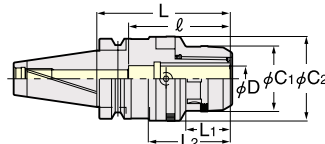
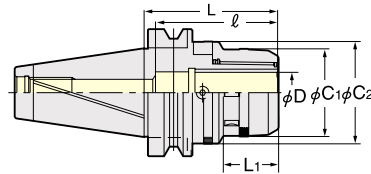

Fig.2



Explation of the Code No.

MBT40-CZF20-105

- Nominal Gauge Length
- Chucking Capacity
- Zero Fit Type Milling Chuck
- Shank No.

MBT-CZF

TAPER	Code No.	C1	C2	L	L1	L2	l	Weight (Kg)	Fig.	Collet
40	MBT40-CZF20-105, 120	51.5	66.5	105, 120	35	64.5	80	2.1, 2.5	1	KM20, CCK20
	-CZF25-105, 120	59.5	74.5	105, 120	35	68	80	2.4, 2.9		KM25, CCK25
	-CZF32-120	69	80.5	120	42	81	105	2.8		KM32, CCK32
50	MBT50-CZF20-105, 165	51.5	66.5	105, 165	35	-	80	4.6, 6.0	2	KM20, CCK20
	-CZF25-105, 165	59.5	74.5	105, 165	35	-	80	5.0, 6.8		KM25, CCK25
	-CZF32-105, 165	69	80.5	105, 165	42	-	105	5.3, 7.4		KM32, CCK32

MIT-CZF

TAPER	Code No.	C1	C2	L	L1	L2	l	Weight (Kg)	Fig.	Collet
40	MIT40-CZF20-105	51.5	66.5	105	35	70	80	2.1	1	KM20, CCK20
	-CZF25-105	59.5	74.5	105	35	70	80	2.4		KM25, CCK25
	-CZF32-120	69	80.5	120	42	85	105	2.8		KM32, CCK32
50	MIT50-CZF20-105	51.5	66.5	105	35	-	80	4.7	2	KM20, CCK20
	-CZF25-105	59.5	74.5	105	35	-	80	5		KM25, CCK25
	-CZF32-120	69	80.5	120	42	-	105	5.3		KM32, CCK32

★Spanner is available as an option.

CZF20 type : 9HC22, CZF25 type : 9HC25, CZF32 type : 9HC32

★Please add "P" at the end of Code No. for the high speed type, e.g. MBT40-CZF25-105P

★For centre through coolant use without collet, please use CKFN-D nut. When the collet is required to use with, please use the CCK Collet and CKFN Nut.

★Spanner for run-out adjustment (9ZFL) is available as an option.

★Please note that the acceptable shank tolerance is h₈-h₇.

3LOCK ZERO FIT TYPE SLIM CHUCK



Photo. shows with J type Nut.

Fig.1

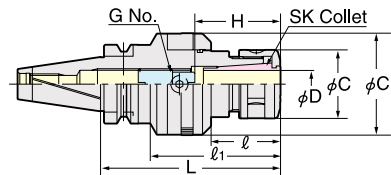
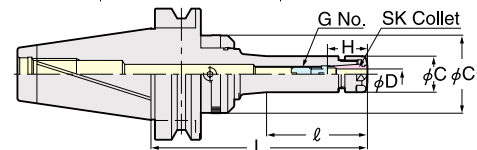

Fig.2



Explation of the Code No.

MBT40-SZF10C-90

- Nominal Gauge Length
- High Pressure Centre Through
- Chucking Capacity
- Zero Fit Type Slim Chuck
- Shank No.

MBT-SZF

TAPER	Code No.	D	L	l	l1	C	C1	H	G No.	Weight (Kg)	Fig.	Collet
40	MBT40-SZF 6C- 90,150	0.7~6.0	90, 150	37, 60	-	19.5	40.5, 48.5	26~31	SKG 6- 6HG	1.3, 1.7	2	SK 6
	-SZF10C- 90,150	1.75~10.0	90, 150	37, 97	-	27.5	48.5	35~41	SKG10-10HG	1.5, 1.9		SK10
	-SZF16C- 90,150	2.75~16.0	90, 150	37, 97	-	40	59.5	45~57	SKG16-12HG	1.8, 2.2	1	SK16
	-SZF25C-120,150	16.0~25.4	120, 150	55, 86	84, 114	55	66.5	60~65	SKG25-18HGD	2.4, 2.9		SK25
50	MBT50-SZF 6C-105,165	0.7~6.0	105, 165	41, 63	-	19.5	40.5, 59.5	26~31	SKG 6- 6HG	4.0, 4.2	2	SK 6
	-SZF10C-105,165	1.75~10.0	105, 165	41, 101	-	27.5	48.5	35~41	SKG10-10HG	4.5, 4.9		SK10
	-SZF16C-105,165	2.75~16.0	105, 165	41, 101	-	40	59.5	45~57	SKG16-12HG	5.0, 5.4	1	SK16
	-SZF25C-135,165	16.0~25.4	135, 165	71, 101	-	55	66.5	60~70	SKG25-24HG	5.8, 6.0		SK25

MIT-SZF

TAPER	Code No.	D	L	l	l1	C	C1	H	G No.	Weight (Kg)	Fig.	Collet
40	MIT40-SZF 6C- 90,150	0.7~6.0	90, 150	45, 89	-	19.5	40.5	26~31	SKG6-6HG	1.3, 1.7	2	SK 6
	-SZF10C-120,150	1.75~10.0	120, 150	57, 87	-	27.5	48.5	35~41	SKG10-10HG	1.6, 1.9		SK10
	-SZF16C-120,150	2.75~16.0	120, 150	51, 81	-	40	59.5	45~57	SKG16-12HG	1.9, 2.2	1	SK16
	-SZF25C-120,150	16.0~25.4	120, 150	49, 79	85, 115	55	66.5	60~65	SKG25-18HGD	2.4, 2.9		SK25
50	MIT50-SZF 6C-105,165	0.7~6.0	105, 165	60, 67	-	19.5	40.5, 59.5	26~31	SKG6-6HG	4.0, 4.2	2	SK 6
	-SZF10C-105,165	1.75~10.0	105, 165	60, 65	-	27.5	48.5, 59.5	35~41	SKG10-10HG	4.5, 4.9		SK10
	-SZF16C-105,165	2.75~16.0	105, 165	60, 120	-	40	59.5	45~57	SKG16-12HG	5.0, 5.4	1	SK16
	-SZF25C-120,165	16.0~25.4	120, 165	75, 120	-	55	66.5	60~65	SKG25-24HG	5.7, 6.0		SK25

★SK nut, adjust screw (G No.) and collet extractor are supplied as standard.

★Run-out adjust spanner (9ZFL) and SKL spanner are available as option.

The code No. for SKL Spanner : SZF6 type : SKL-6W, SZF10 type : SKL-10, SZF16 type : 9HC16, SZF25 type : 9HC22

★For centre through coolant application please use SK J type nut and cap for your preference. Please note that the length of J type nut is 6mm longer than the standard SK Nut.

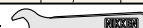

★Please use "P" class or "A" type SK collet.

★Please add "P" at the end of Code No. for the high speed type, e.g. MBT40-SZF10C-90P

HSK ZERO FIT TYPE MILLING CHUCK

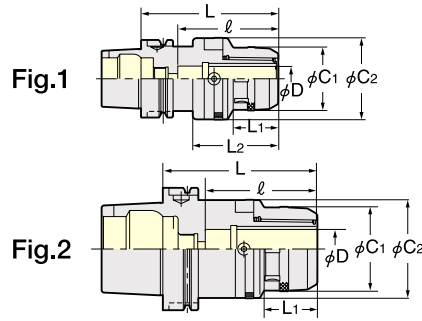

Explanation of the Code No.

HSK63A - **CZF20** - **105**

- Shank No.
- Zero Fit Type Milling Chuck
- Chucking Capacity
- Nominal Gauge Length

HSK-CZF

TAPER	Code No.	C1	C2	L	L1	L2	l	Weight (Kg)	Fig.	Collet
HSK- 63A	HSK- 63A-CZF20-110	51.5	66.5	110	35	68	80	2	1	KM20, CCK20
	-CZF25-110	59.5	74.5					2.5		KM25, CCK25
	-CZF32-130	69	80.5					2.8		KM32, CCK32
HSK-100A	HSK-100A-CZF20-115	51.5	66.5	115	35	-	80	3.5	2	KM20, CCK20
	-CZF25-115	59.5	74.5					3.8		KM25, CCK25
	-CZF32-115	69	80.5					4		KM32, CCK32

★Spanner is available as an option. CZF20 type : 9HC22, CZF25 type : 9HC25, CZF32 type : 9HC32

★Spanner for run-out adjustment (9ZFL) is available as an option. ★Please note that the acceptable shank tolerance is h6~h7.

★Please add "P" at the end of Code No. for the high speed type. e.g. HSK63A-CZF25-110P

★For centre through coolant use without collet, please use CCKF-D nut. When the collet is required to use with, please use the CCK Collet and CCKF Nut.



HSK ZERO FIT TYPE SLIM CHUCK

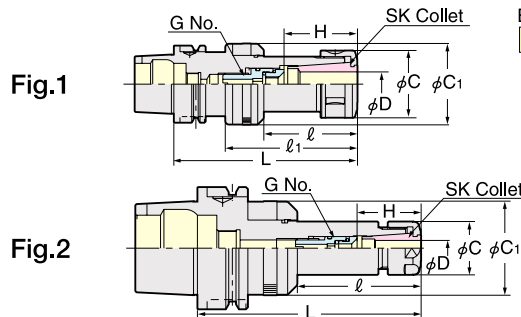

Explanation of the Code No.

HSK63A - **SZF10** **C** - **90**

- Shank No.
- Zero Fit Type Slim Chuck
- Chucking Capacity
- High Pressure Centre Through
- Nominal Gauge Length

HSK-SZF

TAPER	Code No.	D	L	l	l1	C	C1	H	G No.	Weight (Kg)	Fig.	Collet
HSK- 63A	HSK- 63A-SZF 6C-120	0.7~6.0	120	68	-	19.5	40.5	26~31	SKG 6- 6HG	1.2	2	SK 6
	-SZF10C-105, 150	1.75~10.0	105, 150	53, 98	-	27.5	48.5	35~41	SKG10-10HG	1.3, 1.9		SK10
	-SZF16C-150	2.75~16.0	150	76	-	40	59.5	45~57	SKG16-12HG	2	SK16	
	-SZF25C-135	16.0~25.4	135	57	93	55	66.5	60~65	SKG25-18HGE	2.1	1	SK25
HSK-100A	HSK-100A-SZF 6C-120	0.7~6.0	120	64	-	19.5	40.5	26~31	SKG 6- 6HG	2.4	2	SK 6
	-SZF10C-150	1.75~10.0	150	95	-	27.5	48.5	35~41	SKG10-10HG	3.4		SK10
	-SZF16C-150	2.75~16.0			-	40	59.5	45~57	SKG16-12HG	3.7	SK16	
	-SZF25C-150	16.0~25.4			-	55	66.5	60~70	SKG25-18HGE	4.1	SK25	

★SK nut, adjust screw (G No.) and collet extractor are supplied as standard.

★Run-out adjust spanner (9ZFL) and SKL spanner are available as option.

The code No. for SKL Spanner : SZF6 type : SKL-6W, SZF10 type : SKL-10, SZF16 type : 9HC16, SZF25 type : 9HC22

★Please use "P" class or "A" type SK collet.

★Please add "P" at the end of Code No. for the high speed type. e.g. HSK63A-SZF10C-105P

★For centre through coolant application please use SK J type nut and cap for your preference. Please note that the length of J type nut is 6mm longer than the standard SK Nut.



ZERO FIT HOLDER INSTRUCTION (HOW TO ADJUST THE RUN-OUT)

NIKKEN

- Loosen 2 off Cam Ring Lock Screws and rotate the Adjust Cam to the free position. Set the Dial Gauge at front end of the cutting tool.
- Rotate the Zero Fit Holder and stop at the position where the Maximum run-out figure is shown.
- Turn the Cam Ring and locate the Adjust Cam to the "Maximum Run-out" position. Turning the Cam Ring is not affected to the balancing grade, because the Cam Ring itself is well balanced.
- Turn the Adjust Cam by wrench (9ZF) to adjust the run-out to be the middle between the maximum and the minimum. Adjustments made with small movements may take some time to achieve the correct accuracy. It is better to try to adjust the full error in one attempt. With practice this becomes easier.

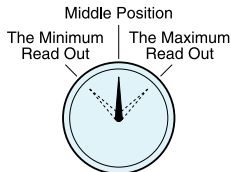
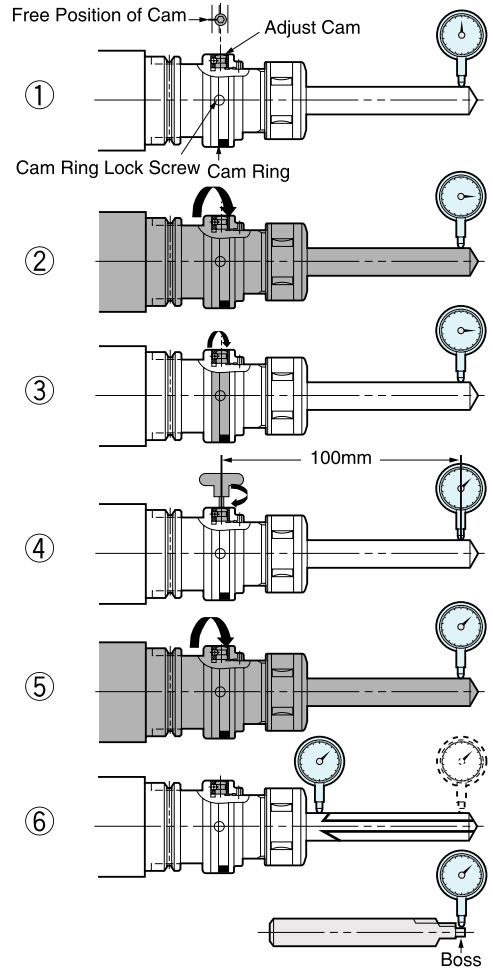

Wrench to adjust
9ZF



Adjustable range of run-out at 100mm from Adjust Cam. (The range will be double at 200mm)	
SZF 6	0.050mm / dia.
SZF10	0.050mm / dia.
SZF16	0.040mm / dia.
SZF25	0.025mm / dia.
CZF20	0.050mm / dia.
CZF25	0.050mm / dia.
CZF32	0.030mm / dia.

- To make sure please rotate the Zero Fit Holder and check the run-out is adjusted correctly. If adjustment is not correct, loosen the screw to get the Adjust Cam back to the free position and repeat the above procedure from ②. Please ensure that the 2 off Cam Ring Lock Screws are tightened after the above operations.
- Please note that there are certain cutters which have the difficulty to check the run-out at their front end. In that case, put the dial gauge on the cylindrical shank portion under the teeth as ⑥ and proceed the above operation ①~⑤. Then, move the dial gauge to the front end and confirm the run-out. If further fine adjustment is required, please do so by using the Adjust Cam only without rotating the Cam ring.

When new special cutter is designed, we will recommend to design to add the boss to check the run-out accuracy at the front end.



- In case of CZF (Milling Chuck) style, please rotate the Adjust Cam to the free position. Then, tighten the nose ring until face contact.
If the face contact is not completed, the Adjust Cam can not function. (Free run)
If the Adjust Cam is not at the free position before tightening, you can not tighten the nose ring until face contact correctly.
- For the safety reason, the Cam Ring Lock Screws can not be loosen to remove to the outside.
Please loose the Cam Ring Lock Screws slightly to rotate the Cam Ring.
- Please make sure that the adjustment is made within above range, or the loosening of the Cam might be hard when the adjustment is done over the range.

NIKKEN KOSAKUSHO WORKS, LTD. OSAKA, JAPAN.

5-1, 1-chome, Minamishinden, Daito-shi, Osaka-fu, Japan. Telephone : 072-869-5820 Telefax : 072-869-6220

U.S.A

LYNDEX-NIKKEN
1468 Armour Boulevard,
Mundelein, ILLINOIS 60060
Tel. (847) 367-4800 Fax. (847) 367-4815

SPAIN

CUTTING TOOL S.L.
POL.UGALDETXXO-PARCELA 28-B, NAVE 6 20180 OIARTZUM
(GIPUZKOA) APARTADO 1421-20080 SAN SEBASTIAN.
Tel. (943) 494144 Fax. (943) 494409

FRANCE

PROCOMO FRANCE S.A.
6, avenue du 1er Mai-Z.A.E.Les Glaises 91127
Palaiseau Cedex
Tel. 01.69.19.17.35 Fax. 01.69.30.64.68

TURKEY

NIKKEN KESICI TAKIMLAR SAN. VE ULUSLARARASI TIC. A. S
BAYAR CAD. NO:105/11, 81090 KOZYATAGI / ISTANBUL, TURKEY
Tel. (0216) 464-0620 Fax. (0216) 373-8181

UK

NIKKEN KOSAKUSHO UK LTD.
Precision House, Barbot Hall Industrial Estate,
Rotherham, South Yorkshire, S61 4RL
Tel. (01709) 366306 Fax. (01709) 376683

KOREA

KOREA NIKKEN LTD.
16-2 MAN SUK-DONG, DONG-KU, INCHON
Tel. (032) 763-4461 Fax. (032) 763-4464

GERMANY

NIKKEN DEUTSCHLAND GmbH
Eisenstraße 9b, 65428 Rüsselsheim
Tel.+0049 (0) 6142/55060-0 Fax.+0049 (0) 6142/55060-60

P.R.CHINA

SHANGHAI ZHONG YAN TRADING CO., LTD.
R.C/12B ZHONG XI BUILDING,
NO.121~123 JIANG SHU ROAD, SHANGHAI
Tel. (021) 6210-2506 Fax. (021) 6210-2083

ITALY

VEGA INTERNATIONAL TOOLS S.P.A
Via Asti N. 9 10026-Santena (TORINO)
Tel. (011) 9456330/40/50~70 Fax. (011) 9456380

<http://www.nikken-world.com>
e-mail : export@nikken-kosakusho.co.jp

SWITZERLAND

NIKKEN SWITZERLAND AG
Sumpfstrasse 32 CH-6300 Zug
Tel. (041) 748-5000 Fax. (041) 748-5001

■ Please give your order to the following agent.

SCANDINAVIA SWEDEN

NIKKEN SCANDINAVIA AB
Säterigatan 27 41764 Göteborg
Tel. (031) 519855 Fax. (031) 519955

D.YF.10

● Specifications are subject to change without notice.